

CertainTeed

MATTERHORN[®]

METAL ROOFING

Tile Installation Guide

ASK ABOUT ALL OF OUR OTHER CERTAINTEED[®] PRODUCTS AND SYSTEMS:

ROOFING • SIDING • TRIM • DECKING • RAILING • FENCE
GYPSUM • CEILINGS • INSULATION

www.certainteed.com <http://blog.certainteed.com>

CertainTeed Corporation
20 Moores Road
Malvern, PA 19355

Professional: 800-233-8990
Consumer: 800-782-8777

© 2016 CertainTeed Corporation, Printed in the U.S.A.
Code No. 20-20-3623

SAINT-GOBAIN

CertainTeed
SAINT-GOBAIN

Table of Contents

- System Components.....2
- General Installation Guidelines3
- Screw and Fastening Specifications4
- Eave Edge/Drip Edge5
- Bird Guard6
- Inner Gable7
- Outer Gable8
- Hip and Ridge9
- Locating Inner Gable or C-Closure10
- Valley11
- Sidewall12
- Stucco Sidewall Detail13
- Endwall14
- Transition15
- Panel to Panel Installation16
- Panel Layout and Installation.....17
- Tools and Accessories18



Watch detailed Matterhorn® Tile installation videos online at certainteed.com

- A. Tile Panel
- B. 1.5 EL T-Style Drip Edge
- C. Hip/Ridge Cap
- D. 2" C-Closure Vented
- E. Ridge Cap End Closure
- F. Inner Gable
- G. Outside Gable
- H. Side Wall Flashing
- I. End Wall Trim
- J. 2" Valley Closure
- K. Valley Closure Cap
- L. .016 x 24" WL W-Valley
- M. .019 GAL Bird Guard
- N. Weep Trim
- O. Wind Stop

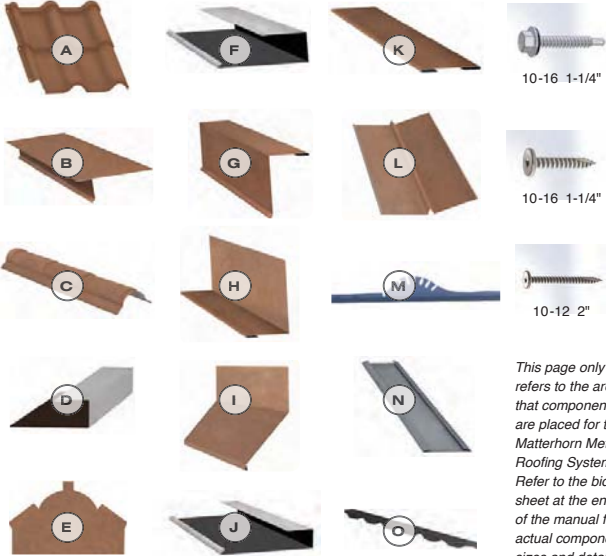

This page only refers to the area that components are placed for the Matterhorn Metal Roofing System. Refer to the bid sheet at the end of the manual for actual components sizes and detailed information.

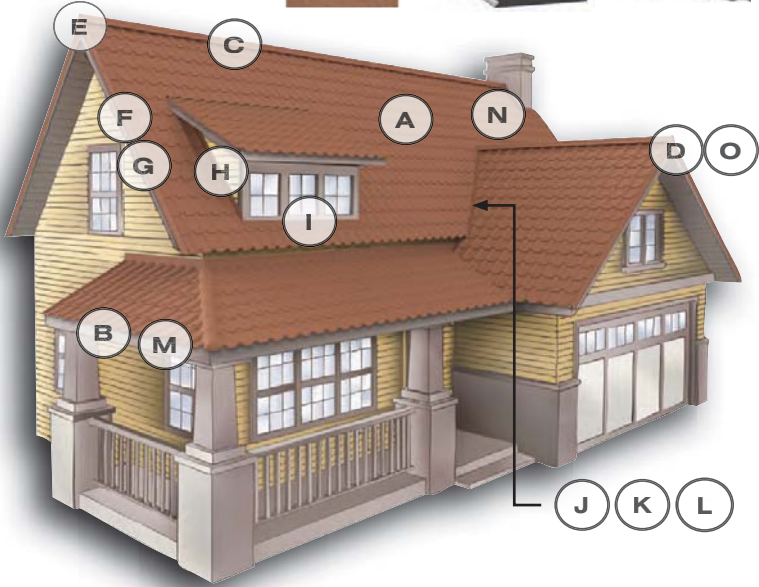

General Installation Guidelines

- CertainTeed recommends tearing off existing roof systems and installing Matterhorn® Metal Roofing over a clean deck.
- Matterhorn Metal Roofing must be installed on a solid roof deck. The roof deck must be 15/32" to 1/2" thick plywood, or 7/16" thick non-veneer or nominal 1" thick wood deck.
- DiamondDeck® synthetic underlayment and MetaLayment/WinterGuard® HT high temperature self-adhering underlayment must be installed prior to the installation of the metal roofing products—refer to local building code.
- MetaLayment/WinterGuard HT is required in all valleys and eaves.
- Slope requirements:
 - 3/12 — 4/12 slope: MetaLayment/WinterGuard HT must be used over the entire roof deck.
 - < 3/12 slope: Do not install Matterhorn Metal Roofing.
- Prior to installing the underlayments, clear the roof deck of any debris or protrusions that could puncture the protective membrane. Installing roof panels on uneven surfaces may cause distortion or deflection on the metal surface. Surface wave in the material is not cause for rejection of the product.
- Inner Gable, Valley, Valley Closure, T-Style Drip Edge, Vented C-Closure, Bird Guard and Bird Stop must be installed before the panels. Sidewall Flashing, Outer Gable, Hip/Ridge Cap, Transition Flashing and Ridge Cap End Closure may also be installed before the panels.
- When cutting panels to length, always remove material so that the factory pre-formed bend remains intact to allow for proper locking to adjacent panel below.
- Always install Matterhorn Tile panels from bottom to top, then right to left; beginning with the bottom right corner of the roof deck. Always fill one column in completely before moving to the next one.
- Be sure each panel is fully engaged to the panel below before fastening it to the deck. This may be done using the heel of your hand.
- Foot traffic: Minimize foot traffic. Wear clean, soft sole, non-marking shoes when walking on installed panels.

- Upon completion of the installation, inspect the roof surface for metal shavings or other loose material. Remove by wiping softly with a cloth, being careful not to scratch the painted surface. Remove dirt with a damp rag, using detergent if necessary.

Safety Guidelines

Follow all governmental safety procedures, including, but not limited to, all OSHA guidelines. Always wear safety gloves, safety glasses and fall protection gear when installing Matterhorn Metal Roofing.

Estimating

It is difficult to estimate the use of drops and cutoffs so typically, cutoffs and drops will not be usable since installation runs in only one direction. This would cause overages in determining material usage. Consider the 18-1/4" x 47-1/4" coverage of each panel while determining the total material needed. Installation always runs from bottom to top, then right side to left side of the area to be covered.

Ventilation

Proper ventilation must be achieved to avoid moisture and heat buildup in the attic space, or between the layers of the building envelope. Consult local building code for NFA (Net Free Area) rating requirements.

- **Intake vs. exhaust:** To achieve maximum airflow through the attic, the amount of intake at the eave must be less than or equal to the exhaust at the ridge.
- **Soffit vents** are found on the underside of the eave overhang. This is the primary source for the intake of air to the attic.
- **Ridge vents** are located at the peak of the roof and are the primary exhaust outlet for accumulated hot, moist air.

Class A Fire Rating

Matterhorn tested using Georgia-Pacific 1/4" DensDeck. For a Class A Fire rating, use Georgia-Pacific 1/4" DensDeck. A Class A Fire rating is not applicable if Matterhorn Tile panels are installed over existing 3-tab shingles.

Screw and Fastening Specifications

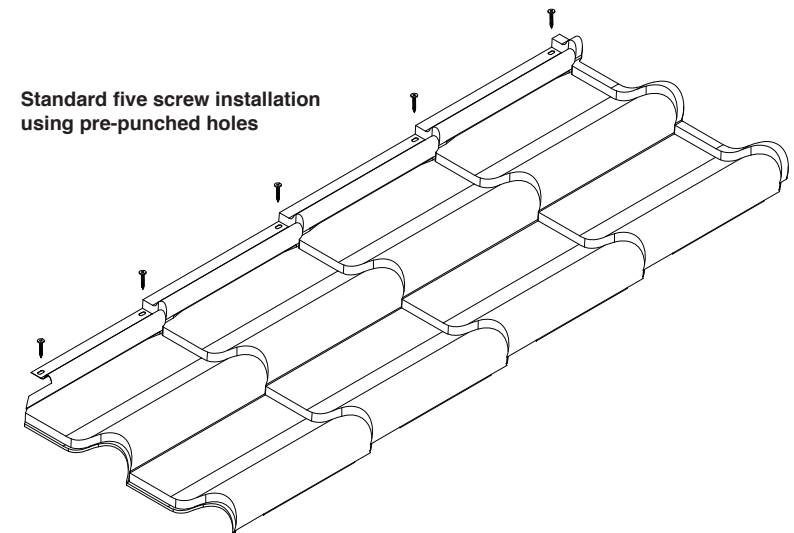
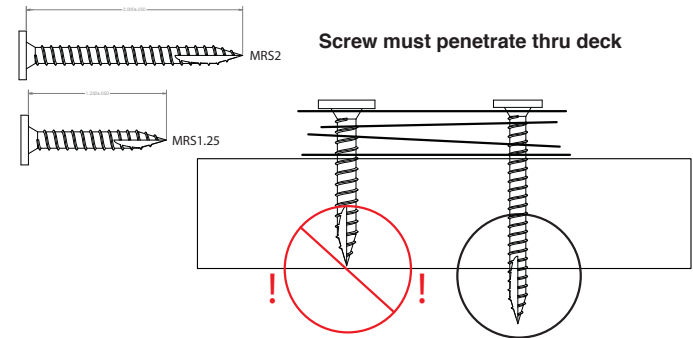

Eave Edge/Drip Edge

1. Fasten drip edge to the roof deck every 12" with panhead screws.
2. Ensure that drip edge is installed securely, the drip edge is designed to hold down the bottom of the first row of panels.
3. When installing, ensure that drip edge is straight and square to the roof plane and does not follow any wave in the fascia. This may require a chalk line.
4. Matterhorn® drip edge is designed to be installed on up to a 12/12 pitch without modification. On steeper roof pitches, drip edge can be bent in a siding brake for easier installation. By bending forward the leg of the drip edge it will fit tight on a steep slope roof.
5. Bird Guard should be installed between the drip edge and the underside of the panel at the eave edge only.

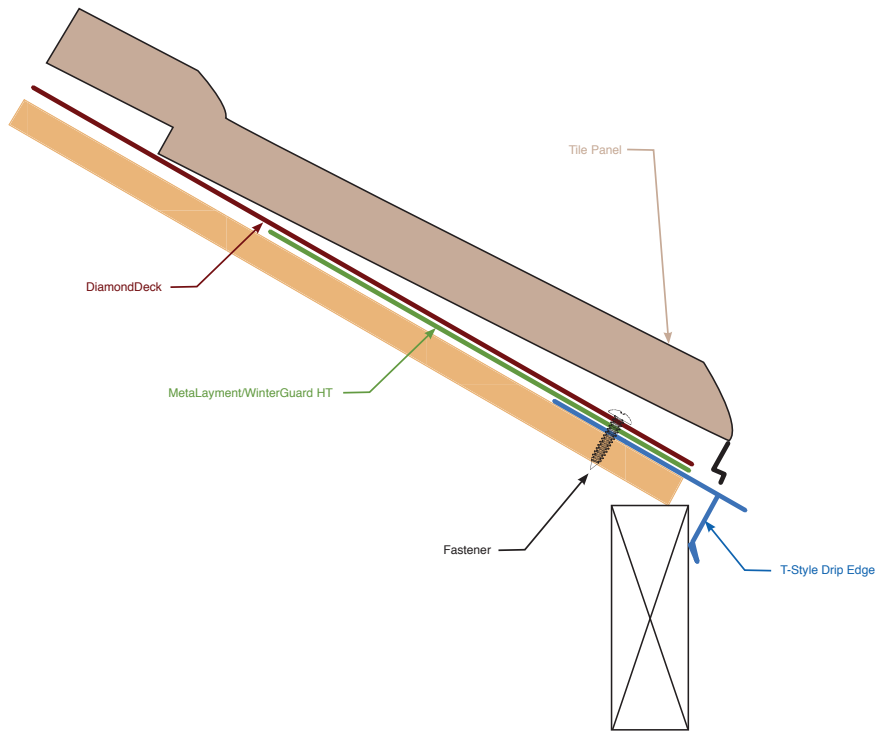

5

Watch detailed Matterhorn® Tile installation videos online at certainteed.com

Bird Guard

Bird Guard should be installed between the drip edge and the underside of the panel at the eave edge only.

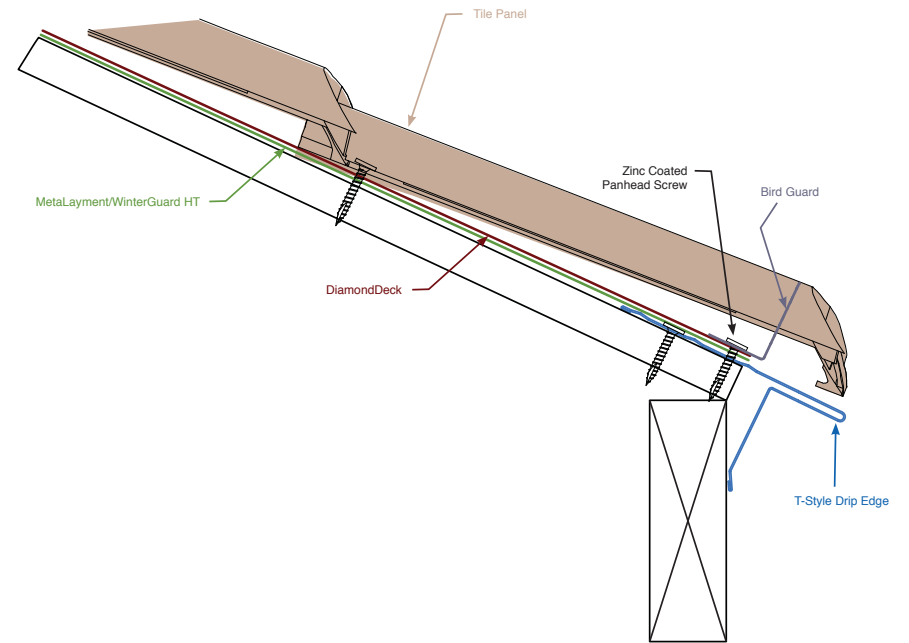

6

Watch detailed Matterhorn® Tile installation videos online at certainteed.com

Inner Gable

1. Install the inner gable up the rake edges using panhead screws every 12". The opening of the inner gable should face toward the roof deck. The back side should align with the outside edge of the roof deck.
2. Overlap inner gable trim as per the sequence below. Overlap by at least 6".
3. In high wind areas check your local code requirements for approved installation techniques.

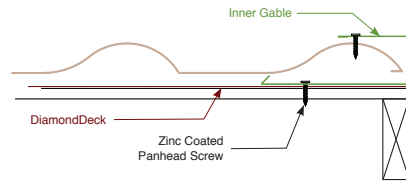

Cut bottom of inner gable so outside weeping channel will protrude past drip edge 1/4".



Cut out top leg of inner gable trim to allow for tight, waterproof overlapping.



When overlapping, apply sealant under overlap. Be sure to screw every 12" between the diverter and the water lock.



Install inner gable as a whole piece. When adding a second inner gable trim, open up the water lock and cut out the top section to allow for tight, overlapping, waterproof fit.



Refit the overlapping water locks together with a hand seamer.

Outer Gable

1. Install the outer gable over the inner gable. This may require opening the hem slightly.
2. Make sure the outer gable fits parallel with the inner gable and the lap joint is staggered with the inner gable lap joint.
3. Outer gable should be hemmed to inner gable and fastened with painted 5/8" hex head screw.

Note: For high-wind areas additional fasteners may be needed into the fascia. Consult local codes to determine if your area is a high wind area.

Option 1: Using outer gable

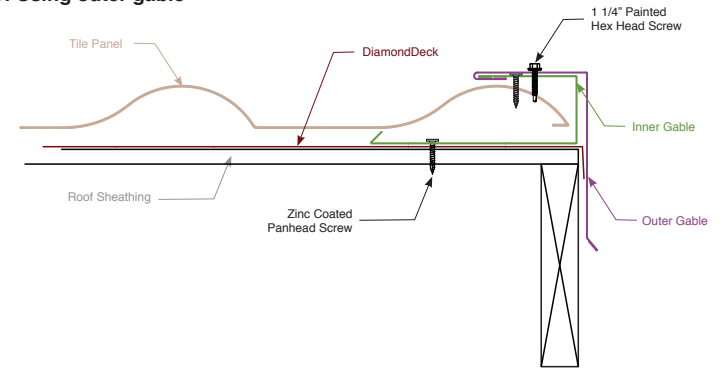

Option 2: Using ridge caps on the rake

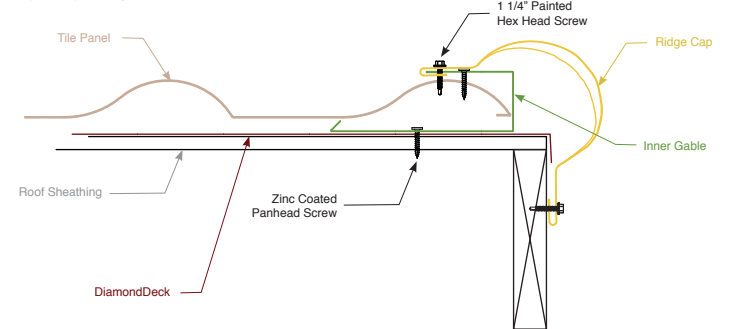

Hip and Ridge

Hip and Ridge Detail(s):

Hip and ridge capping can be installed before the roof panels to prevent walking on the finished roof. For vented ridges, the vented C-Closure is fastened to the deck every 12" with panhead screws. For unvented hips or ridges the inner gable is installed with panhead screw every 12". Be sure the inner gable or vented c-closure are properly spaced to engage the hem of the hip/ridge cap. When overlapping the cap sections, be sure to maintain the correct spacing end to end by nesting the ridge cap together. A shorter flange on the ridge cap can be achieved by moving the closures closer together.

For a 130 MPH wind rating, fasten cap to the tile through the closure with color matched screws at every barrel top.

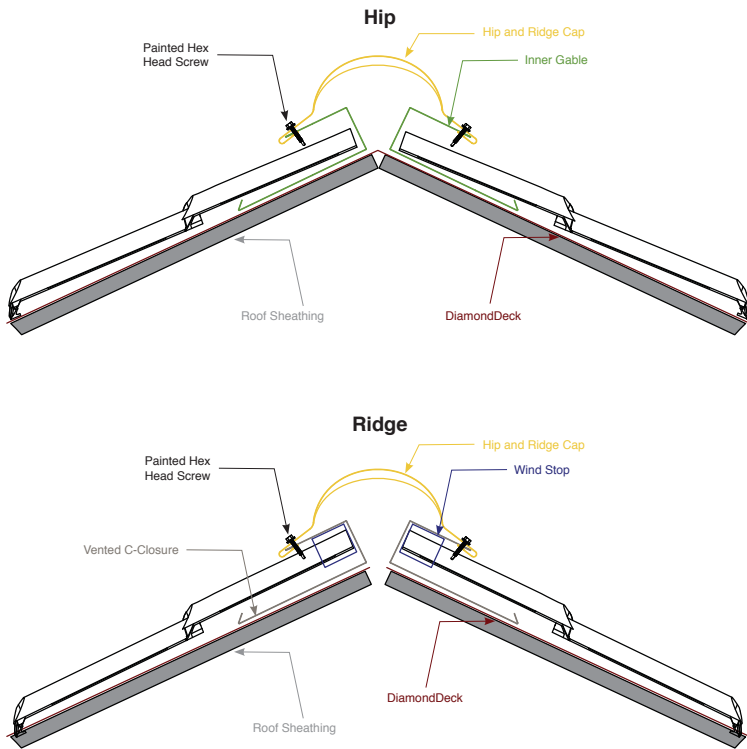

Locating Inner Gable or C-Closure

To set the spacing of the hip or ridge, use the ridge cap as your guide

1. Slide a Ridge Cap over the inner gable or Vented C-Closure at one end before screwing it to the hip or ridge.
2. Set the assembly on the hip or ridge and position the end with the cap where needed.
3. Screw down the Inner Gable or Vented C-Closure at the end with the Ridge Cap.
4. Slide the Ridge Cap down the Inner Gable or Vented C-Closure to the other end.
5. Position that end with the cap where needed and screw down.
6. Carry on these steps along the hip or ridge.

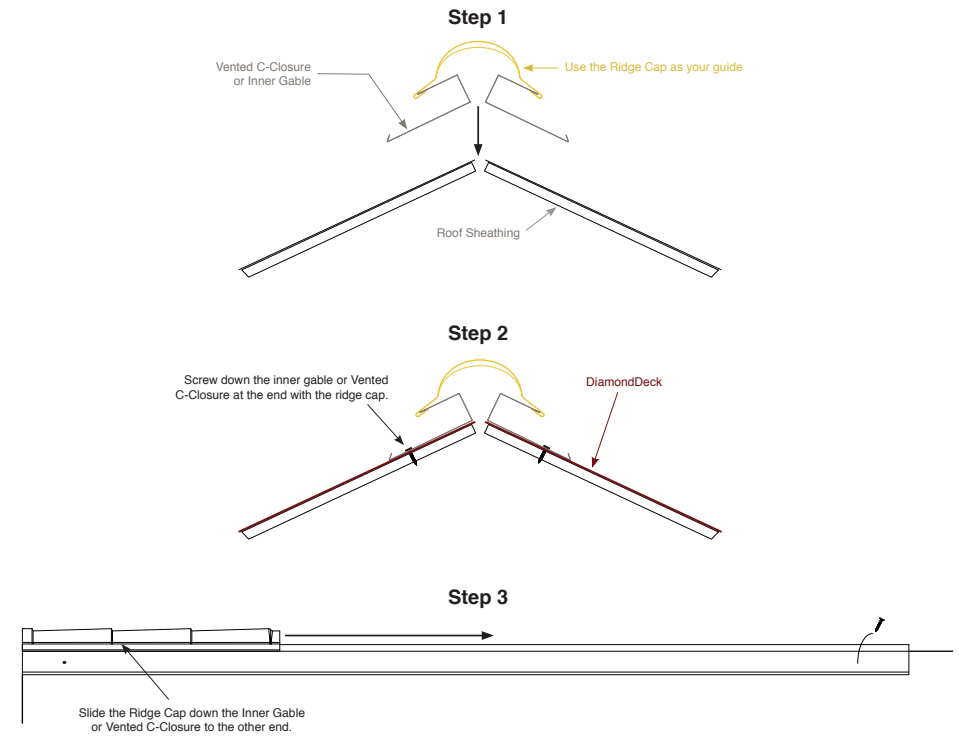

Valley

Valley Detail #1: Closed Valley (3 Pieces)

1. Fully line the valley of the roof with MetaLayment/WinterGuard HT.
2. Install the opposing pieces of valley closure back to back. Fasten every two feet within one inch of the water lock with pan head screws.
3. Slide the valley cap up the valley starting at the eave. Make sure the cap stays hemmed to the valley closure. Additional sections may be added for long roof valleys.

For a 130 MPH wind rating, fasten every 12" through the valley cap into the barrel top.

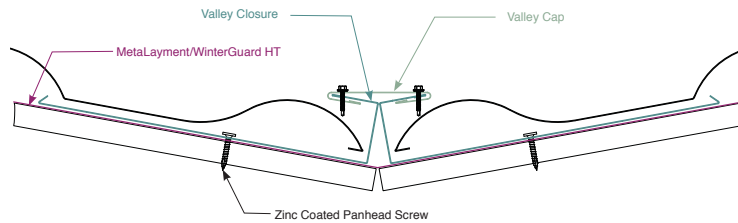

Valley Detail #2: Open Valley

1. Install valley closure over hang the drip edge on the inside corner, 6" out of the lowest point.
2. Cut the bottom hem of the first panel at the bottom of the valley closure. This will allow water to flow out of the valley at the bottom and not block flow.
3. Cut the roof panels at the angle of the valley, fitting it as close to the inside of the valley closure as possible. Extra fasteners may be needed to secure the panels in the valley. Be sure not to fasten within 6" of the bottom.
4. When joining valley sections, apply sealant and install valley closure to be water tight. Apply sealant neatly and completely along all sides of the valley trim.
5. Both sides of the valley closure need to be water tight.
6. On a gable protrusion, when installing panels into valley, take frequent measurements to ensure that the first course above the valley peak will be aligned horizontally. At the bottom of all trim pieces, allow for weeping of water. Panels will need to be notched out to allow water to escape.

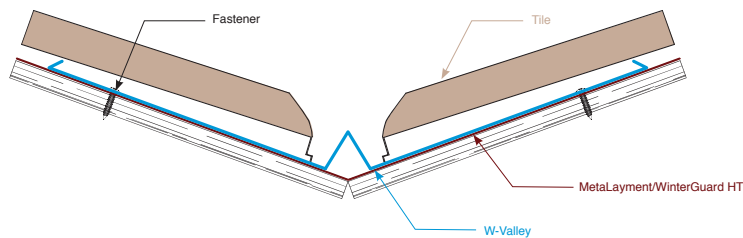

Sidewall

Sidewall Detail:

1. Cut roof panel of the last row to the remaining width needed to meet the sidewall.
2. Install inner gable before the last panel, fastening every 12" just inside the water lock.
3. Install the panel with the cut edge against the inner gable. Fasten the top of the inner gable into the panel at the high spots with pan head screws.
4. Install the sidewall flashing over both the panel and the inner gable, hooking the sidewall flash hem on to the edge of the inner gable.
5. Fasten the sidewall flashing into the sidewall or fit behind the siding to secure.
6. When installing along a chimney, be sure the sidewall flashing is sealed to the brick or a reglet is cut into the mortar joints.

For a 130 MPH wind rating, fasten through the sidewall flashing into the tile panel every 12".

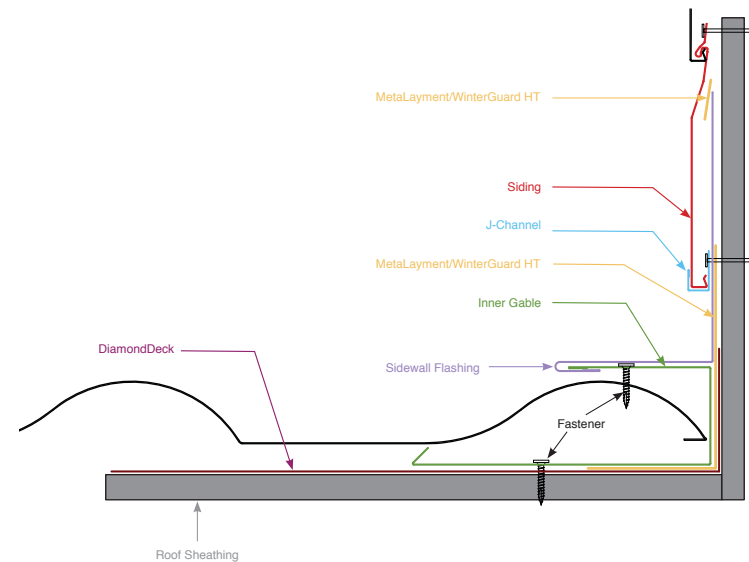

Stucco Sidewall Detail Using Inner Gable and Sidewall Flashing

Endwall

Endwall Detail with Inner Gable:

1. Fasten the inner gable to the roof deck with panhead screws every 12".
2. Fasten the endwall flashing into the endwall with the hem hooked into the inner gable.
3. Lap endwall flashing behind the siding or seal to the endwall as needed.
4. When installing up to a chimney, be sure counter/endwall flashing is sealed to the brick.
For a 130 MPH wind rating, fasten through the inner gable into the tile panel every 12".

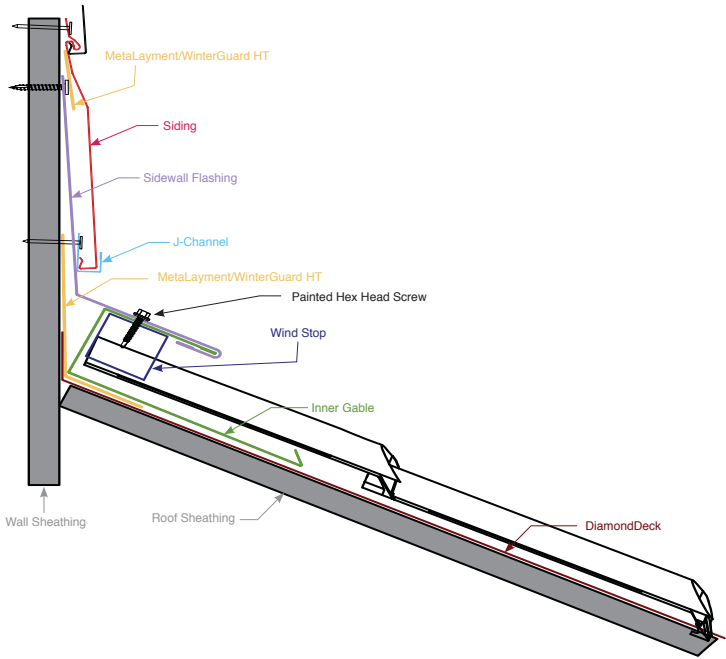
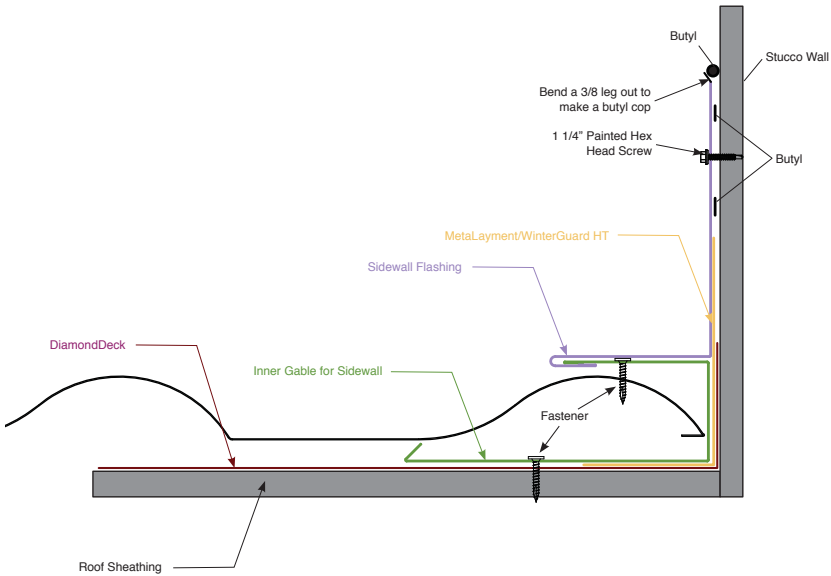

Transition

Transition Detail:

1. Install inner gable, sealing the bottom to the roof deck at the roof angle change.
2. Install the transition flashing with the lower hem hooked into the inner gable.
3. Install the upper roof section first over the transition flashing along the bottom edge, filling the voids with Bird Guard.
4. Then install the lower roof section under the transition flashing, fitting the panels all the way up into the inner gable.

For a 130 MPH wind rating, fasten through the inner gable into the tile panel every 12".

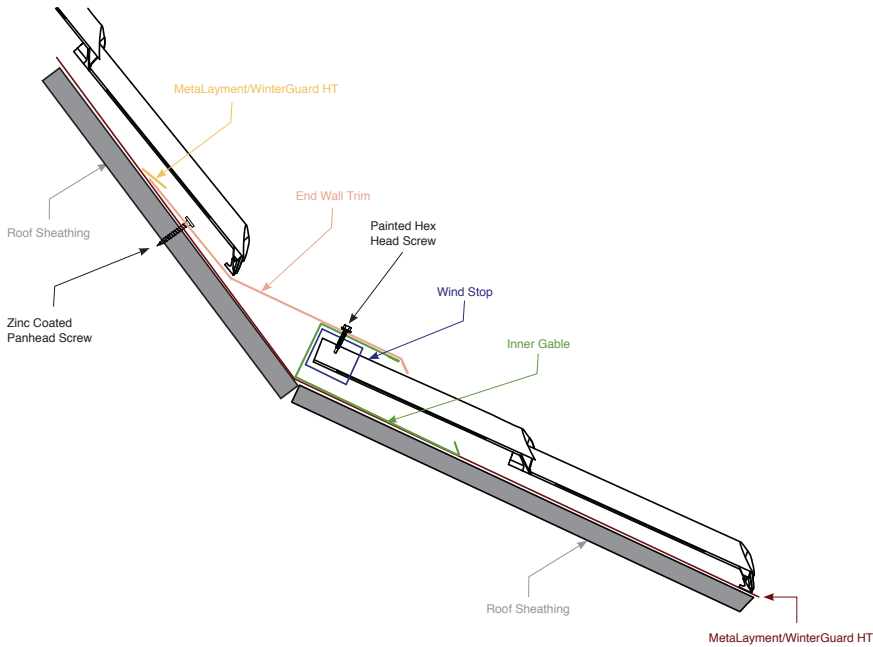

Panel to Panel Installation

1. Prior to installing the panels over the underlayment, clear the roof deck of any debris that could puncture the underlayment.
2. Always install tile panels from bottom to top, then right to left; beginning with the bottom right corner of the roof deck. Always fill one column in completely before moving to the next one.
3. To fully engage the panel to the previous row, start the panel down and to the right, engage the mating hook and flange, after the flange is started press the panel to the left and up to fully engage. Take care not to over engage the panel in the mating pocket.
4. Be sure each panel is fully engaged to the panel below and to the right before fastening it to the deck.

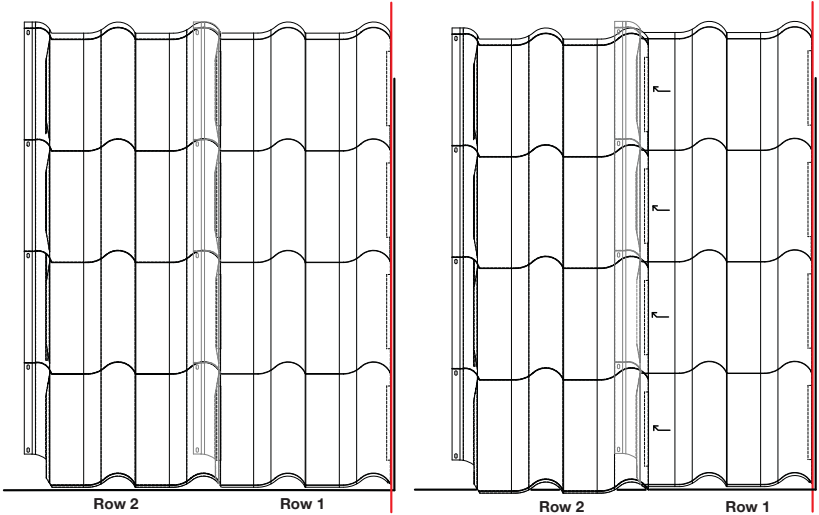

Panel Layout and Installation

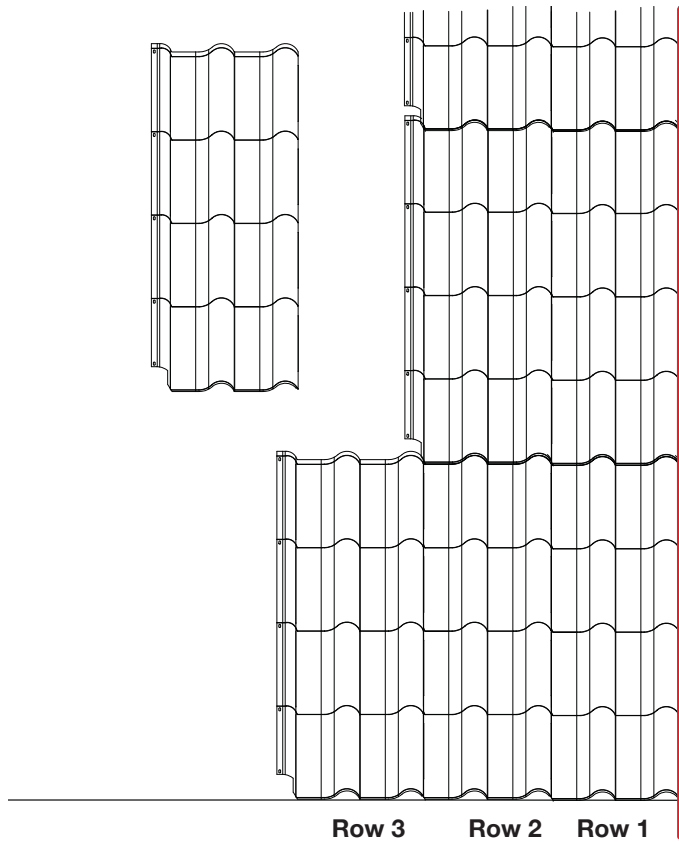

Row 3 Row 2 Row 1

Tools and Accessories

Required Tools

(Minimum recommend tools and equipment):

The standard set of tools and equipment in the general roofing trade.

Including: Cordless driver, snips, tape measure, electric metal saw, caulking gun, chalk line, hand seamer/hemming tool, gloves, square, felt tipped marker, needle nose pliers and a small flat head screw driver.



Cordless Driver



Tin Snips



Chalk Line



Sheet Metal Gloves



Hand Seamer



Foam Pad

Special Additional Tools:

Not needed to complete the job but can improve install procedures and provide an overall finished look.



Sheet Metal Brake



Power Shears



Ladder Hook



Table Saw



Circular Saw

Accessories

(Most available through local roofing distributors):

Caulk: Butyl or urethane caulk/sealant

Tape: Butyl tape, or flashing tape on a roll, for side and end wall flashing

Boots: For vent pipes with metal sealer ring

Snow Guards: Should be placed as needed, and always refer to the manufacturing instruction guide when installing. Refer to local distributor for more information.